

*J Series shown with Standard Base (J) and #1 Classic moldings*

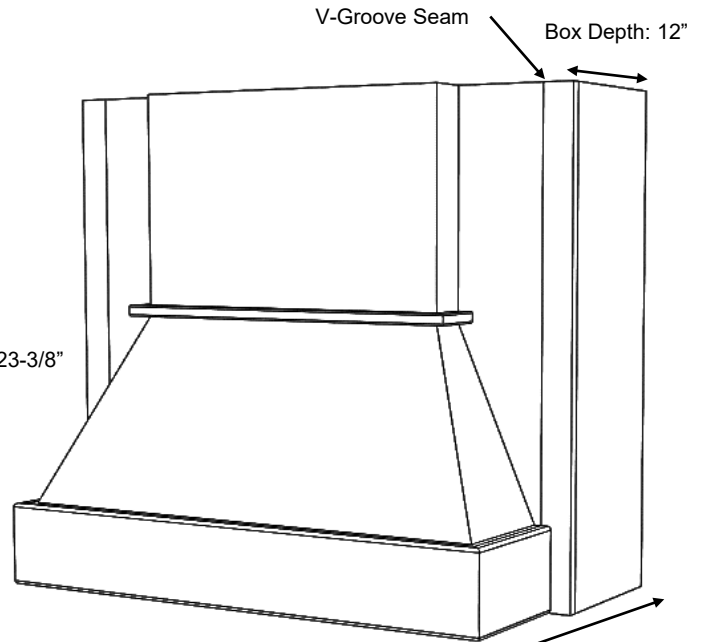

*J Series shown with Hardwood Base (JHW)*

### J Series

Standard Widths	33, 36, 39, 42, 45, 48, 51, 54, 57, 60, 63 (Reduced widths available)
Standard Heights	30, 36, 42, 48 (Reduced heights available)
Removable Options	Removable Front (RF) – Rear Box will be 14" – see modifications section. Applied Removable Panel (ARP) – see modifications section.
Available Options	12" Rear Box can be modified by request.
Ventilation	Hood must be a minimum of 3" wider than available vent width. Example: To use a 36" vent model, the hood should be a minimum of 39" wide
Available Moldings	#1 Classic, #2 Simple, #3 Basic
Grain Direction	Vertical (Base is horizontal)

Standard Heights: 30, 36, 42, 48

#### J- Standard Base

J 33  
J 36  
J 39  
J 42  
J 45  
J 48  
J 51  
J 54  
J 57  
J 60  
J 63

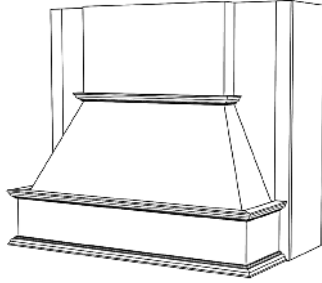

#### J- Hardwood Base

JHW 33  
JHW 36  
JHW 39  
JHW 42  
JHW 45  
JHW 48  
JHW 51  
JHW 54  
JHW 57  
JHW 60  
JHW 63

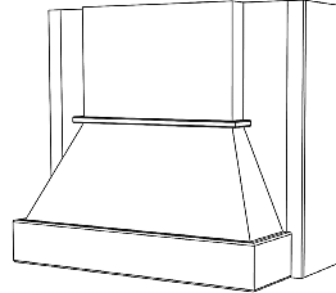

#### J- RS Base

JRS 33  
JRS 36  
JRS 39  
JRS 42  
JRS 45  
JRS 48  
JRS 51  
JRS 54  
JRS 57  
JRS 60  
JRS 63

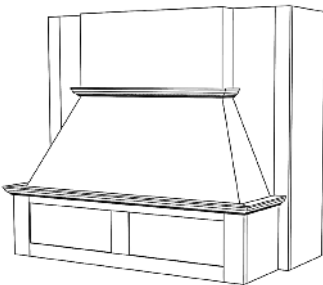

#### J- RSS Base

JRSS 33  
JRSS 36  
JRSS 39  
JRSS 42  
JRSS 45  
JRSS 48  
JRSS 51  
JRSS 54  
JRSS 57  
JRSS 60  
JRSS 63

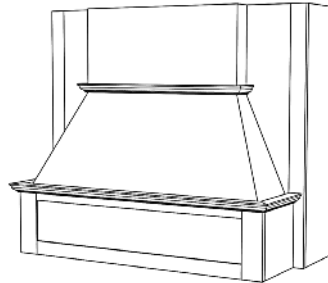

#### J- RA Base

JRA 33  
JRA 36  
JRA 39  
JRA 42  
JRA 45  
JRA 48  
JRA 51  
JRA 54  
JRA 57  
JRA 60  
JRA 63

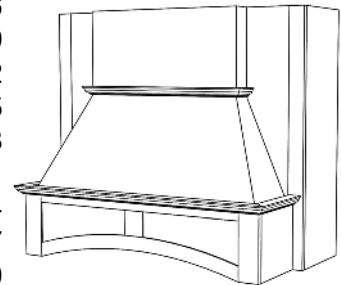

#### J- DP2 Base

JDP2 33  
JDP2 36  
JDP2 39  
JDP2 42  
JDP2 45  
JDP2 48  
JDP2 51  
JDP2 54  
JDP2 57  
JDP2 60  
JDP2 63

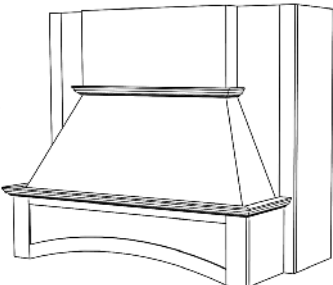

#### J- SL Base

JSL 33  
JSL 36  
JSL 39  
JSL 42  
JSL 45  
JSL 48  
JSL 51  
JSL 54  
JSL 57  
JSL 60  
JSL 63

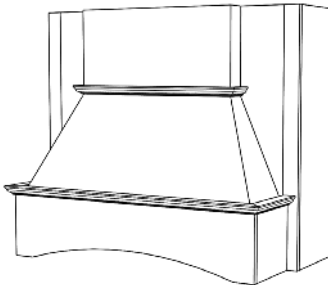

#### J- DP1 Base

JDP1 33  
JDP1 36  
JDP1 39  
JDP1 42  
JDP1 45  
JDP1 48  
JDP1 51  
JDP1 54  
JDP1 57  
JDP1 60  
JDP1 63

