

Depth is 22-1/4"

*E Series shown with Hardwood Base (EHW)*

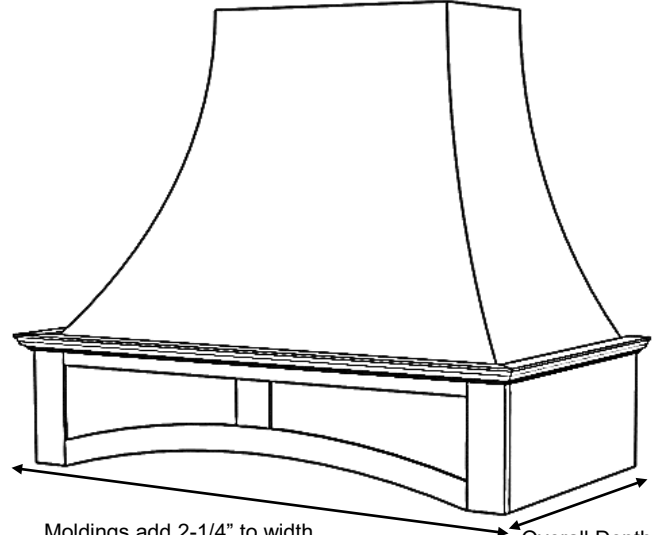

Moldings add 2-1/4" to width

Overall Depth is 23-3/8"

*E Series shown with RA Base (ERA) and #1 Classic molding*

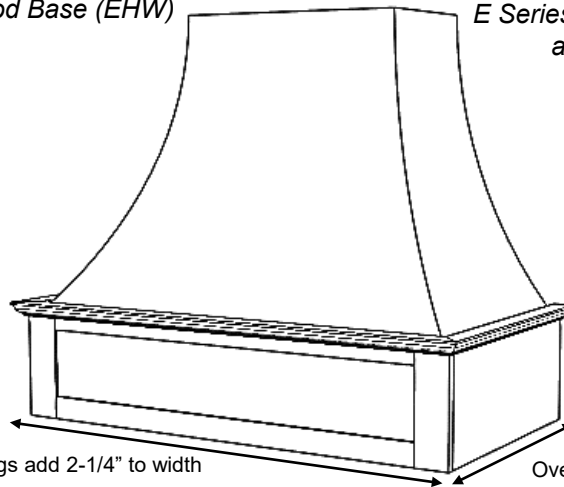

Moldings add 2-1/4" to width

Overall Depth is 23-3/8"

*E Series shown with RSS Base (ERSS) and #1 Classic molding*

## E Series

Standard Widths	36, 42, 48, 54, 60 (Reduced widths available)
Standard Heights	30, 36, 42, 48 (Reduced heights available)
Removable Options	Removable Top (RT) – see modifications section.
Available Options	Hardwood Battens (See batten options page)
Ventilation	Hood will be same width as available vent width. Example: To use a 36" vent model, the hood should be a minimum of 36" wide
Available Moldings	#1 Classic, #2 Simple, #3 Basic
Grain Direction	Vertical (Base is horizontal)

Standard Heights: 30, 36, 42, 48

#### E- Standard Base

E 36  
E 42  
E 48  
E 54  
E 60

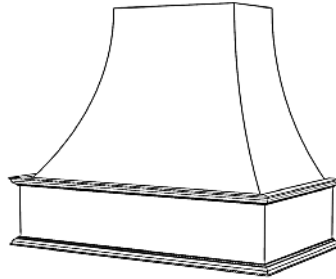

#### E- Hardwood Base

EHW 36  
EHW 42  
EHW 48  
EHW 54  
EHW 60

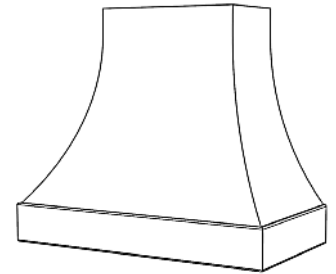

#### E- RS Base

ERS 36  
ERS 42  
ERS 48  
ERS 54  
ERS 60

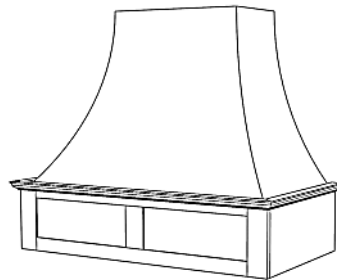

#### E- RSS Base

ERSS 36  
ERSS 42  
ERSS 48  
ERSS 54  
ERSS 60

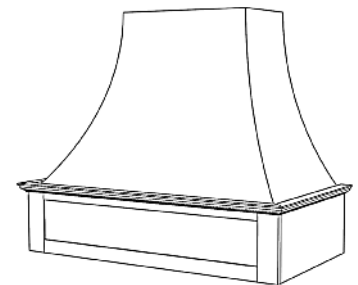

#### E- RA Base

ERA 36  
ERA 42  
ERA 48  
ERA 54  
ERA 60

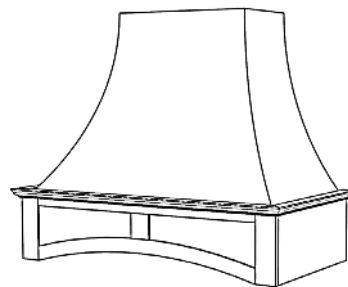

#### E- DP2 Base

EDP2 36  
EDP2 42  
EDP2 48  
EDP2 54  
EDP2 60

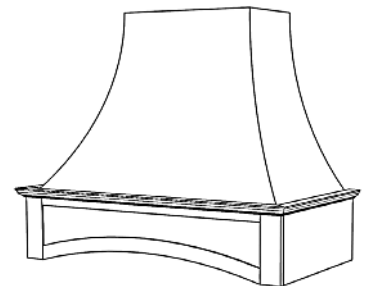

#### E- SL Base

ESL 36  
ESL 42  
ESL 48  
ESL 54  
ESL 60

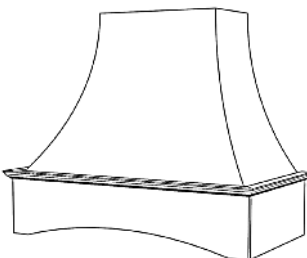

#### E- DP1 Base

EDP1 36  
EDP1 42  
EDP1 48  
EDP1 54  
EDP1 60

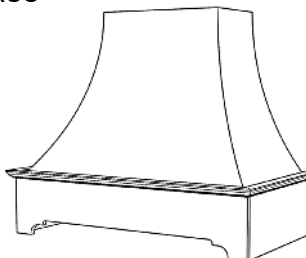

#### E- SS Base

ESS 36  
ESS 42  
ESS 48  
ESS 54  
ESS 60

